

Owner Instructions

Original Instructions

CAUTION Read instructions before using the machine



Operating Instructions

WV 570

WVD 570

WV 750

WV 750T

WVD 750

WVD 750T

WV 900

WVD 900

WVD 1800-DH

WVD 1800-PH

WVD 1800-AP



**WVD
1800DH**



WVD 1800DH WVD 1800PH WVD 1800AP



BS7



WV 570 WV 900
WVD 570 WVD 900



BS8

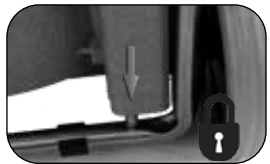
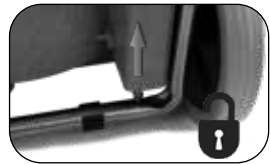
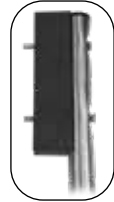
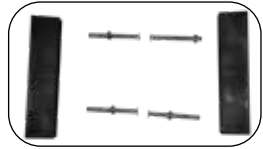

WV 900 / WVD 900



1



2

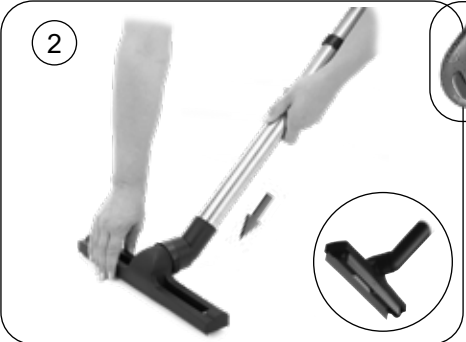

3



4



*WVD 1800PH
WVD 1800AP*



*WD 570
WVD 570
WV 900
WVD 900
WVD 1800DH*



*WVD 1800PH
WVD 1800AP*





WV 570 / WVD 570

WV 570 / WVD 570



WV 900 / WVD 900

WV 900 / WVD 900



WV 750T / WVD 750T

WV 750T / WVD 750T

Wet - Emptying the machine



Wet - Emptying the machine.



WVD 1800DH



WVD 1800DH



WVD 1800PH

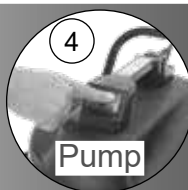

Pump



5

6

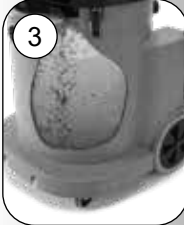
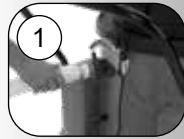

WVD 1800AP



WVD 1800 AP

Wet - Emptying the machine

WVD 1800DH / WVD 1800PH / WVD 1800AP

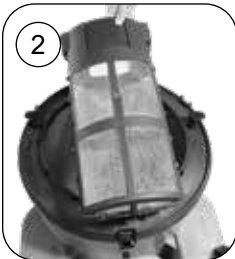

Cleaning the filter

7

WV 570
WVD 570
WV 900
WVD 900



WV 570 / WVD 570
NVM - 3BH



WV 900 / WVD 900
NVM - 4BH





Data

WV / WVD 570

	Motor	AirFlo	Suction	Cleaning Range	Class
WV570 WVD 570	1060 W 1060 W x 2	49 L/sec 98 L/sec	2400 mm w.g. 2400 mm w.g.	26.8m 26.8m	II
	Capacity Dry	Capacity Wet	Size	Weight	Sound Pressure
WV 570 WVD 570	23 Ltrs 23 Ltrs	15 Ltrs 15 Ltrs	415 x 415 x 645 mm	16.3 Kgs 18.5 Kgs	73.6-79 dB (IEC 60704-2-1) Uncertainty: 0.2 dB (A)

WV / WVD 750 (T)

	Motor	AirFlo	Suction	Cleaning Range	Class
WV750 WVD 750 WVD 750 T	1060 W 1060 W x 2 1060 W x 2	49 L/sec 98 L/sec 98 L/sec	2400 mm w.g. 2400 mm w.g. 2400 mm w.g.	26.8m 26.8m 26.8m	II II II
	Capacity Dry	Capacity Wet	Size	Weight	Sound Pressure (LpA) Uncertainty (KpA)
WV750 WVD 750 WVD 750 T	35 Ltrs 35 Ltrs 35 Ltrs	25 Ltrs 25 Ltrs 25 Ltrs	680 x 550 x 940 mm	21.4 Kgs	77.5-76.9 dB

WV / WVD 900

	Motor	AirFlo	Suction	Cleaning Range	Class
WV900 WVD 900	1060 W 1060 W x 2	49 L/sec 98 L/sec	2400 mm w.g. 2400 mm w.g.	26.8m 26.8m	II II
	Capacity Dry	Capacity Wet	Size	Weight	Sound Pressure (LpA) Uncertainty (KpA)
WV 900 WVD 900	40 Ltrs 40 Ltrs	32 Ltrs 32 Ltrs	490 x 800 x 880 mm	25.2 Kgs 28 Kgs	73.6-79 dB

WV / WVD 1800 DH / PH / AP

	Motor	AirFlo	Suction	Cleaning Range	Class
WV 1800DH WVD 1800DH WV 1800PH WVD 1800PH WV 1800AP WVD 1800AP	1060 W 1060 W x 2 1060 W 1060 W x 2 1060 W 1060 W x 2	49 L/sec 98 L/sec 49 L/sec 98 L/sec 49 L/sec 98 L/sec	2400 mm w.g. 2400 mm w.g. 2400 mm w.g. 2400 mm w.g. 2400 mm w.g. 2400 mm w.g.	26.8m 26.8m 26.8m 26.8m 26.8m 26.8m	II II I I I I
	PH / AP Pump Motor	Capacity Wet	Size	Weight	Sound Pressure (LpA) Uncertainty (KpA)
WV / WVD 1800DH WV / WVD 1800PH WV / WVD 1800AP	---- 50W 500W	70 Ltrs 70 Ltrs 70 Ltrs	684 x 785 x 935 mm	31.5 / 34 Kgs 40.4 Kgs 40.4 Kgs	73-77 dB

(GB) About your machine

Rating Label

1	Company Name & Address
2	Model
3	Voltage/Alternating Current
4	Frequency
5	Rated Input Power
6	Weight
7	Ingress Protection
8	WEEE Logo
9	Protection Class 2 Symbol
10	Approval Mark
11	Machine yr/wk Serial Number

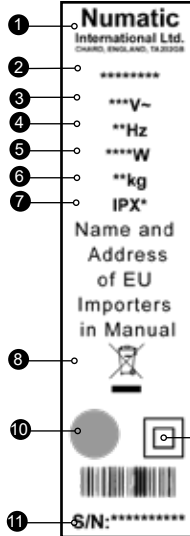

Daily

Keep the machine clean, including hoses and tubes.

Ensure the bag and filter are fitted, (Dry use). Empty dust bag if required.

Clean and check float safety valve for signs of damage.

Regularly examine the power cord. Check filters are clean.

Weekly - as daily and:-

Check for any worn or damaged parts and replace immediately.

MAINTENANCE

WEEE Legislation (Waste, Electrical and Electronic Equipment)

Vacuum cleaner, accessories and packaging should be sorted for environmentally - friendly recycling.

(Only for EU Countries)

Do not dispose of vacuum cleaner into household waste! According to the European Directive 2012/19/EU on waste electrical and electronic equipment and its incorporation into national law.

Vacuum cleaners that are no longer suitable for use must be separately collected and sent for recovery in an environmentally - friendly manner.



PPE (personal protective equipment). That may be required for certain operations.

Ear Protection	Safety Footwear	Head Protection	Safety Gloves	
				Caution Floor Sign
Eye Protection	Protective Clothing	Dust / Allergens Protection	Hi Viz Jacket	

NOTE: A risk assessment should be conducted to determine which PPE should be worn.

Failure to rectify the problem or in the event of a breakdown contact your Numatic dealer or the Numatic Technical helpline +44 (0)1460 269268

Safety Critical Components

Mains leads:	HO5VV-F x 10m x 2 Core x 1.00mm ²
	HO5VV-F x 10m x 2 Core x 2.50mm ²
	HO5VV-F x 10m x 3 Core x 1.50mm ²

Information for WET & DRY use Vacuum Cleaners

Warning

Read the instruction manual before using the machine.

Operators shall be adequately instructed on the use of these machines.

As with all electrical equipment, care and attention must be exercised at all times during use, in addition to ensuring that routine and preventative maintenance is carried out periodically to ensure safe operation. Failure to carry out maintenance as necessary, including the replacement of parts to the correct standard could render this equipment unsafe and the manufacturer can accept no responsibility in this respect.

The machine shall be disconnected from the mains power by removing the plug from the power supply socket during cleaning or maintenance and when replacing parts or converting the machine to another function.

This machine is not to be used by children or persons with reduced physical, sensory or mental capabilities, or lack of experience or knowledge.

Children being supervised are NOT to play with the machine.

This appliance is intended to be assembled, cleaned and maintained by an adult.

This machine is not a toy.

This machine is not suitable for picking up hazardous or explosive dust. Contact your local distributor if you require a machine capable of performing these tasks.

Caution

If foam/liquid comes out of machine exhaust, switch off immediately.

Allow the accumulated liquid to drain out through the machine exhaust, check the float assembly to ensure correct operation, empty the container if full of liquid, reassemble the machine.

Immediately upon start up there will be a certain amount of liquid issuing from the machine exhaust which will be the residue of liquid still within the power head. This will be quickly discharged after which the machine should function normally.

Liquid ejected from the machine could be hazardous as a result of its temperature, pressure or chemical content.

Ensure that the filtration system fitted to the machine is suitable for the material being collected.

This machine is for indoor use only.

This machine shall be stored indoors only. .

When moving from one place to another, consider the weight of the machine.

Notes

You must ensure that the filtration system fitted to the machine is suitable for the material being collected.

This product complies with the requirements of clause 20 of IEC/EN 60335-2-69 Stability and Mechanical Hazards.

The primary use for this machine is commercial, for example in hotels, schools, hospitals, factories, shops and offices.

If the vacuum cleaner stops working, remove the plug from the power supply before investigating where the fault lies.

The vacuum cleaner should be inspected after use for damage.

The power light will illuminate, when your machine is connected to a suitable power supply (where fitted).

Do

- Use a bag and filter at all times when using 'dry'.
- Keep your machine clean.
- Keep filters clean.
- Regularly clean the water level limiting float safety valve and examine for signs of damage or correct operation.
- Keep hoses and tubes clear.
- Replace any worn or damaged parts immediately.
- Regularly examine the power cord, if damage is found, the power cord must be replaced by a special cord available from Numatic or its service agents.

Don't

- Use steam cleaners or pressure washers to clean the machine or use the machine in the rain.
- Immerse in water for cleaning.
- Allow any inexperienced repairs. Call the experts.
- Use wet if float valve is not functioning or fitted.
- Use to suck up hot ashes, or lighted cigarette ends.
- Run the machine over the power cable during operation as a hazard may occur.
- Pull on the cable to unplug the machine from the power supply.
- Walk over-wet carpets, upholstery or fabrics.
- Walk on clean carpets until fully dry.
- Attempt machine maintenance or cleaning unless the power supply plug has been removed from the supply outlet.
- Under any circumstances place foreign objects including (but not limited to) air fresheners, air freshener capsules or scented beads of any type into the top filter of the machine. Doing so can be dangerous and risk damage to the machine and may invalidate the machine warranty.

Dry Mode maintenance/fault finding

If the vacuum cleaner stops working switch off and remove the plug from the wall before investigating where the fault lies. If the vacuum cleaner will not pick up any debris from the surface, switch off and remove the plug from the wall, inspect the floor tool, wands and hose for blockages, if no blockages are found, the dust bag may be full if the dust bag is not full the filter may be blocked.

Wet mode

If the vacuum cleaner stops working switch off and remove the plug from the wall before investigating where the fault lies. If the vacuum cleaner has a blockage and will not pick up liquid, switch off and remove the plug from the wall, has the float valve operated, this will shut off the suction and the pitch of the vacuum motor will change. Remove the power head and empty the liquid out of the container, if the container is empty, check that the floor tool wands and hose are not blocked. Flush the system with clean water after use. After use always inspect the machine for damage.

	Failure to rectify the problem or in the event of a breakdown contact your Numatic dealer or the Numatic Technical Helpline +44 (0)1450 259268
	Wenn Sie das Problem nicht beheben können oder wenn es zu einer Störung kommt, wenden Sie sich an Ihren Numatic-Händler oder rufen Sie bei der Numatic Technical Helpline an unter 0049 (0)511 5642160.
	Si vous ne parvenez pas résoudre le problème ou en cas de panne, contactez votre revendeur Numatic ou le service d'assistance technique Numatic au +33164726191
	Neem contact op met uw Numatic-verdeler als u het probleem niet kunt verhelpen of de machine dienst weigert. U kunt ook de technische hulplijn van Numatic bellen op +31 172 467 999
	Failure to rectify the problem or in the event of a breakdown contact your Numatic dealer or the Numatic Technical Helpline 0661 686 284

14" WVD Duplex 230V WD-0255 (A06)

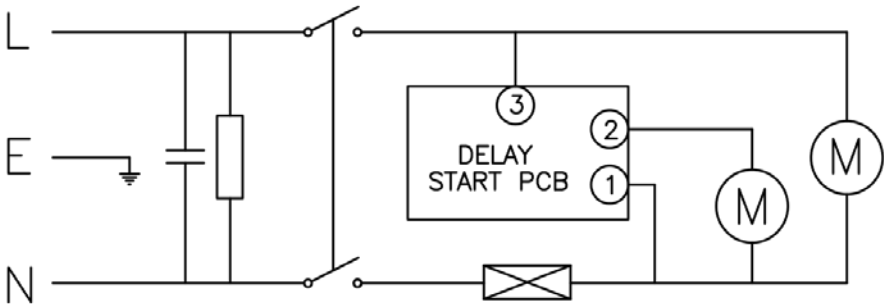

14" WV Simplex 240V / 120V WD-0245 (A05)

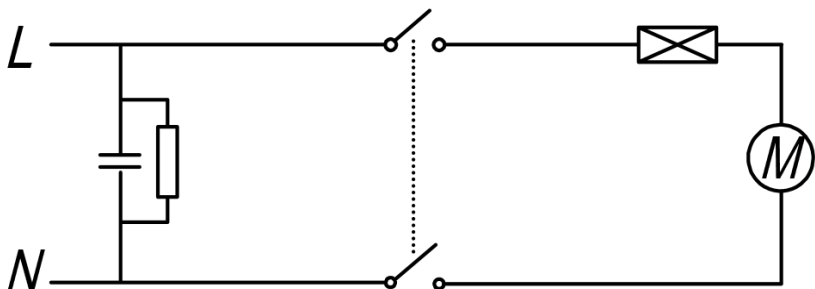

14" Simplex AP/PH 240V / 120V
WD-0244 (A03)

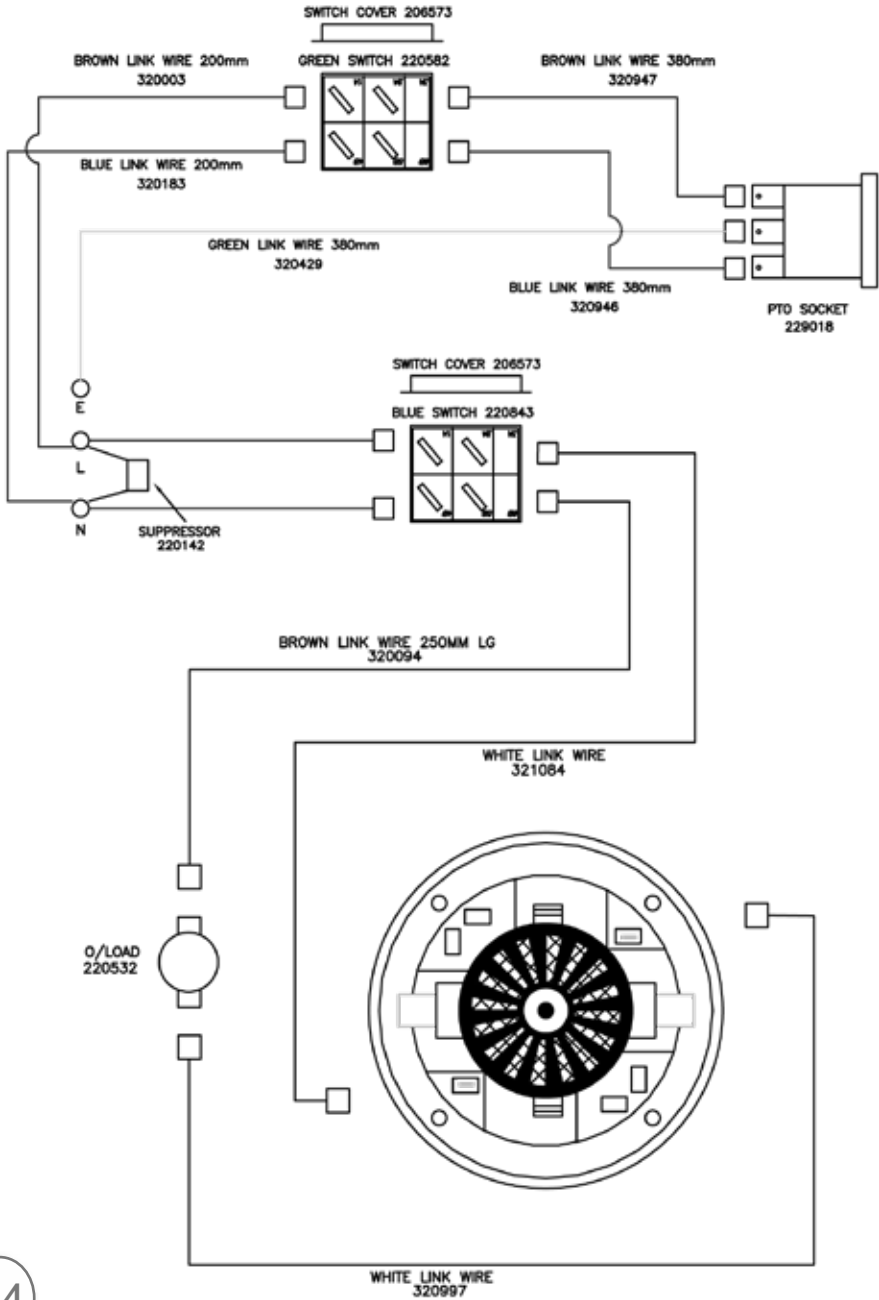

14" Duplex PTO 240V WD-0246 (A06)

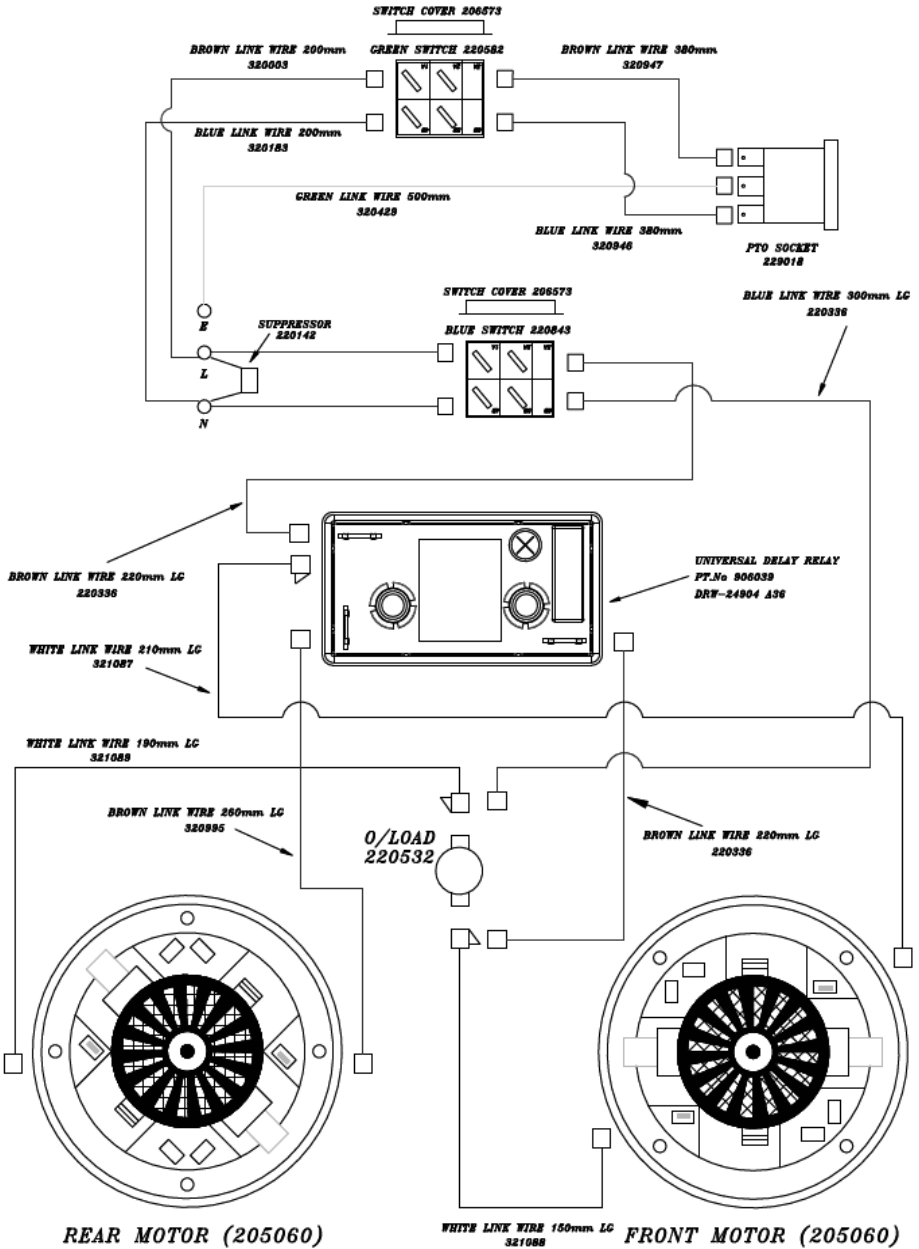

14" WV Simplex AP/PH 220V
17/03/05 WD-0288 (A01)

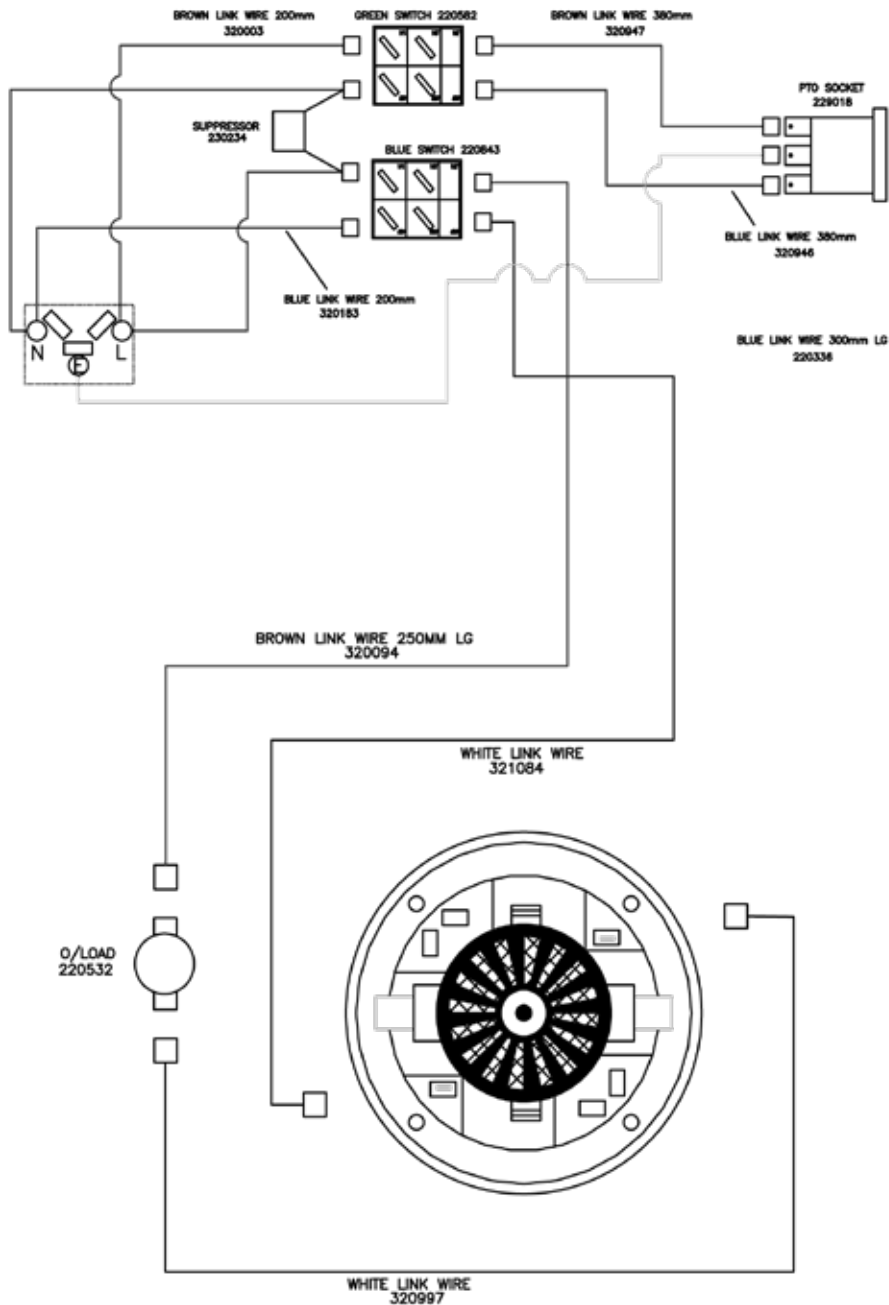

14" WV Duplex 120V
WD-0257 (A03)

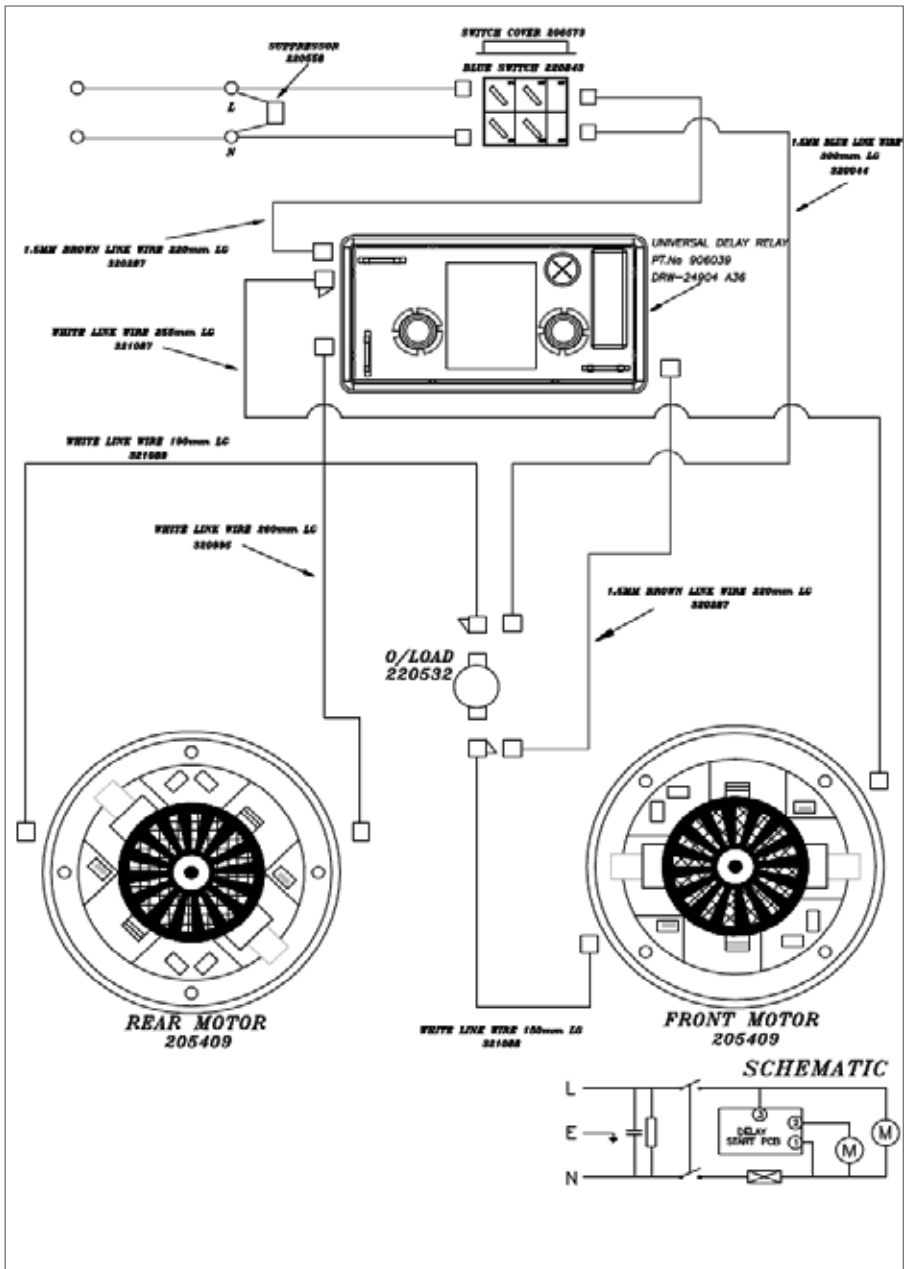

Wiring Diagram

14" WV Simplex 220V
WD-0289 (A01)

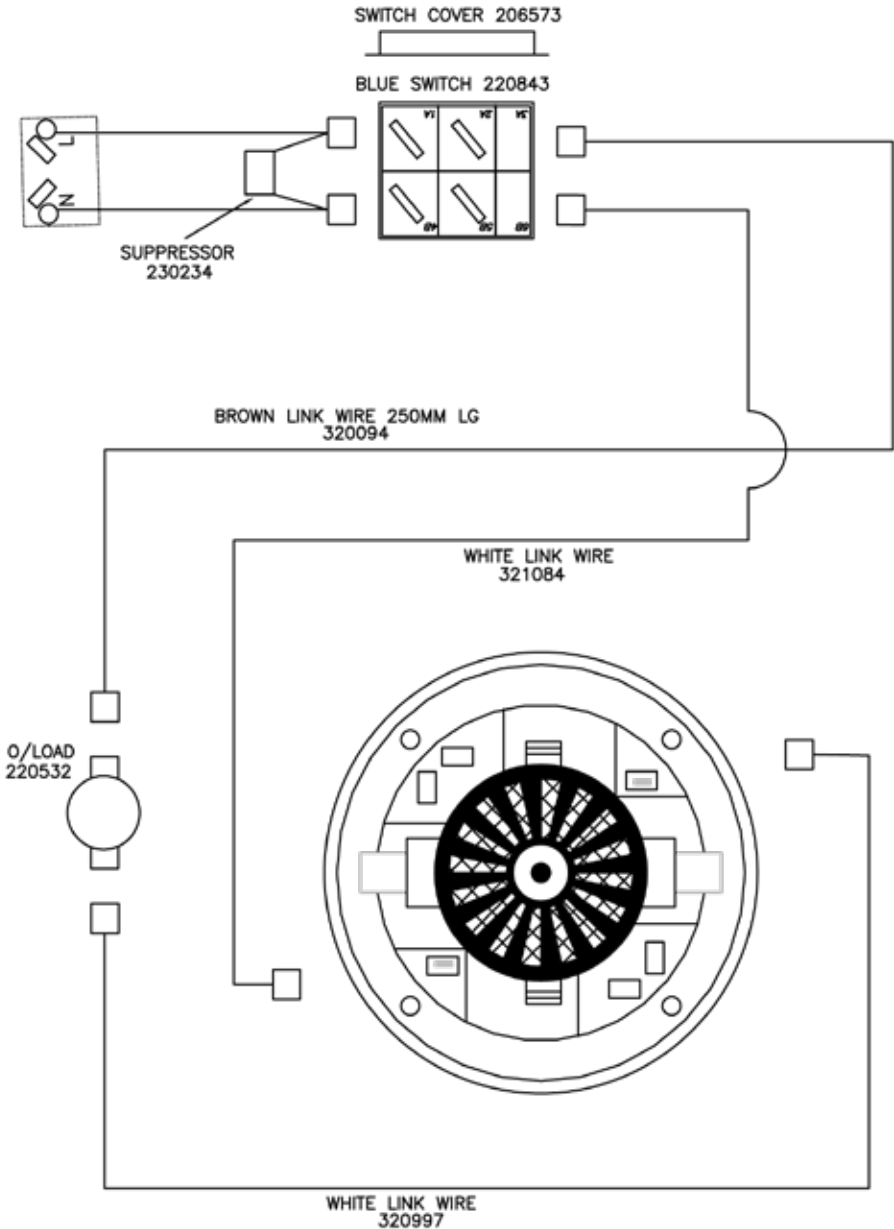

14" WV Duplex AP/PH 220V WD-0290 (A03)

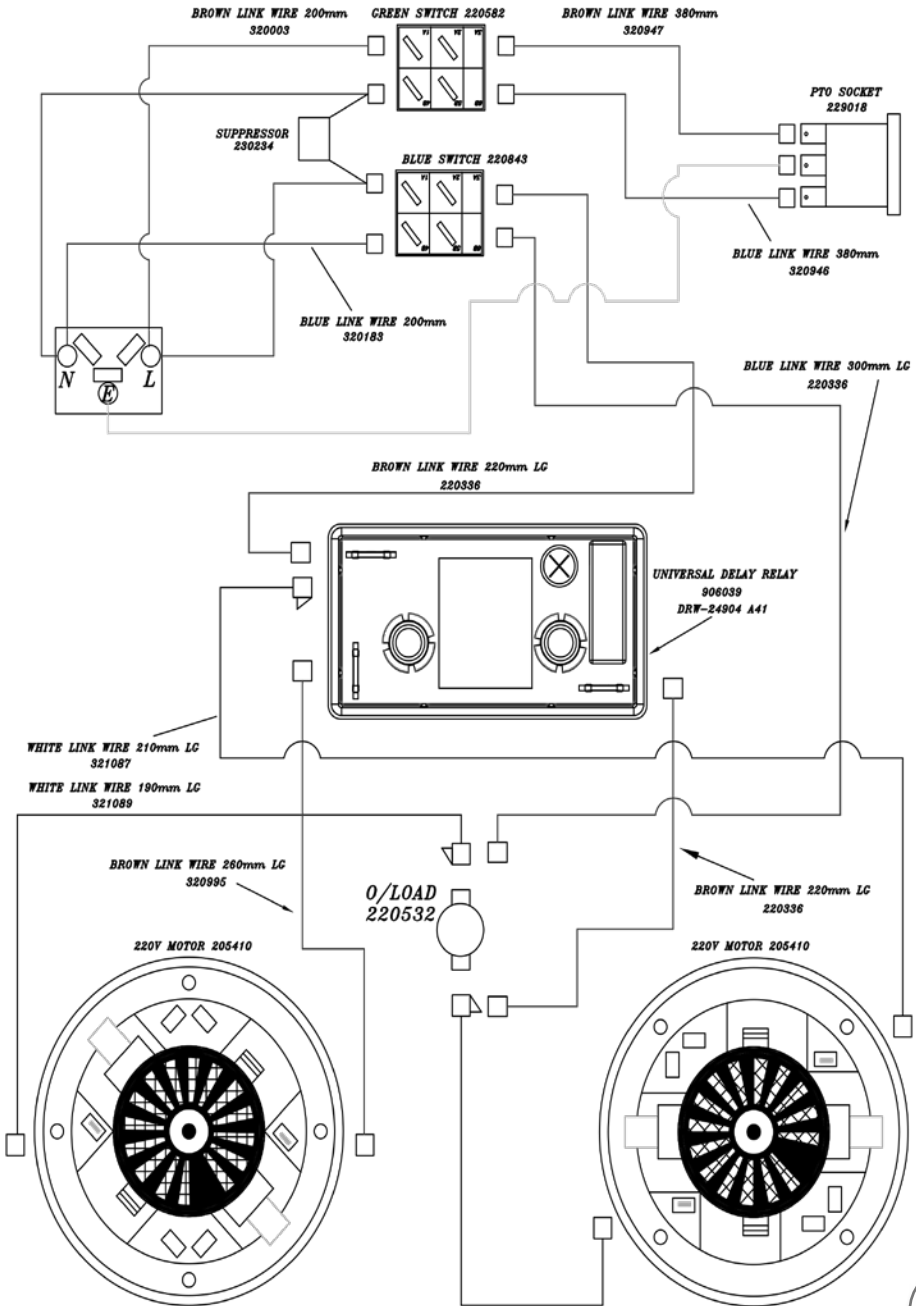

Wiring Diagram

14" WV Duplex 220V
WD-0293 (A03)

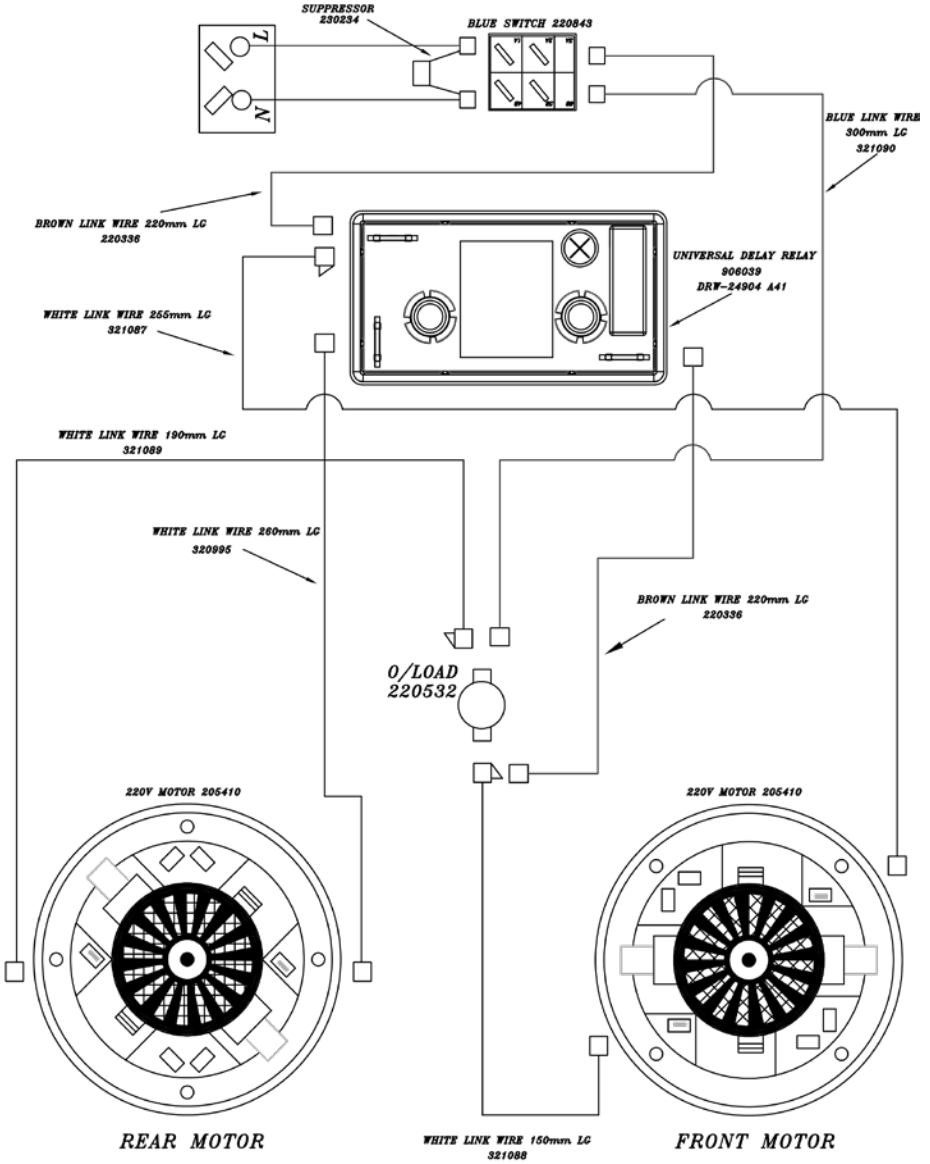

14" WV Duplex PTO120V WD-0259 (A03)

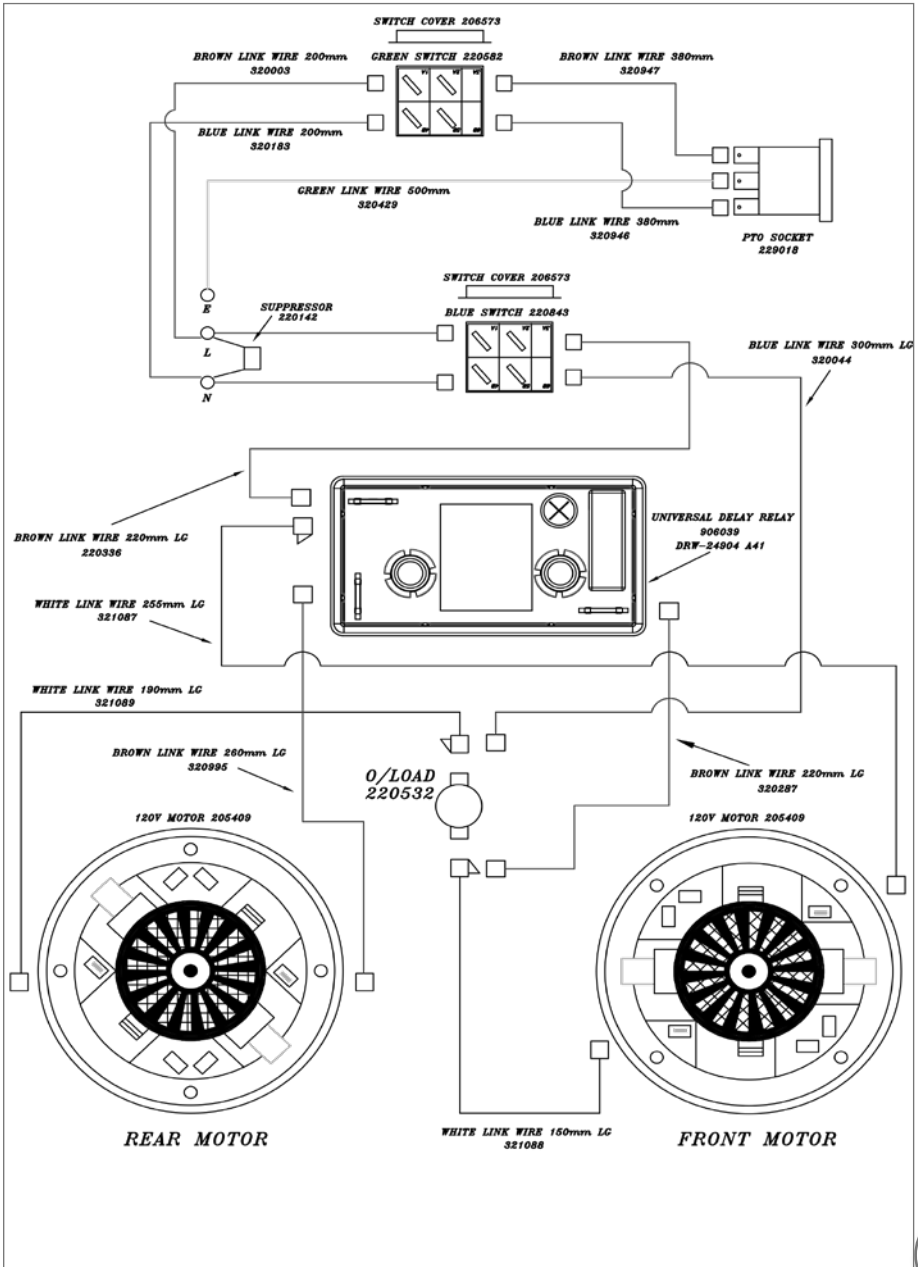

Numatic International Warranty

Numatic International Limited warrant to the original purchaser that its products are free of defects in both material or workmanship for the period shown below:-

Homecare and Cleancare Vacuum cleaners.....	2 Years
Rotary Floor Machines.....	2 Years
Twintec Auto Scrubber Dryer.....	1 Year
Vario Ride-On Scrubber Dryer.....	1 Year / 1500 hours
Mopping, Compacts, Combi and Servocare Products.....	1 Year
Individual Accessories and Spare Parts.....	6 Months

Note: This warranty expressly excludes consumable parts such as carbon brushes, floor brushes, mops, batteries etc, that are considered replaceable from time to time during the normal working life of the machine.

Using non Numatic dustbags can be detrimental to both machine performance and life and may invalidate the Warranty.

- A. The warranty period commences from the date the goods are purchased.*
- B. All warranty claims must be processed through the Dealer from whom the equipment was purchased. The Dealer will co-operate with the purchaser throughout the warranty claims procedure and will arrange any necessary repairs using genuine Numatic parts.*
- C. If the original Dealer is no longer able to fulfil his obligations please contact Numatic International Limited with full details of the claim and proof of purchase so that this may be processed without delay.*
- D. Any warranty claim can only relate to the specific part that is proven to be at fault and for which a replacement will be supplied but cannot be extended to constitute a claim against the complete machine.*
- E. Numatic International will supply the Dealer with any warranty parts required, subject to the claim being validated, after return of the faulty items in accordance with Numatic International Limited's General Conditions of Sale.*
- F. Claims will not be accepted if they are the result of fair wear and tear, misuse or abuse of any kind.*
- G. No replacement will be given unless the appropriate evidence of the validity of the claim has been provided to the satisfaction of Numatic International Limited.*
- H. Numatic International Limited reserve the right to charge for any unnecessary work carried out as a result of an invalid claim.*
- I. No variation to this warranty may be made or implied by any member of Numatic International Limited or its Dealers unless such variation is in writing and authorised by the Company.*



Numatic International Limited, Chard, Somerset, TA20 2GB

Telephone: 01460 68600 Fax: 01460 68458

© Numatic International Limited

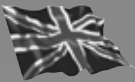

Numatic International Limited.
Chard, Somerset TA20 2GB ENGLAND
Tel: 01460 68600 www.numatic.co.uk

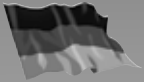

Numatic International GmbH. Fränkische Straße 15–19
D-30455 Hannover, DEUTSCHLAND
Tel: 05 11 98 42 16 0 www.numatic.de

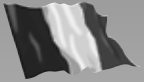

Numatic International SAS. 13 / 17 rue du Valengelier
EAE La Tuilerie – 77500 CHELLES, FRANCE
Tel: 01 64 72 61 61 www.numatic.fr



Numatic International BV
Vennootsweg 15, 2404 CG, Alphen aan den Rijn, NEDERLAND
Tel: 0172 467 999 www.numatic.nl

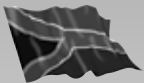

Numatic International (Pty.) Ltd.
16th & Pharmaceutical Roads, Midrand, Gauteng,
SOUTH AFRICA 1685
Tel: 0861 686 284 www.numatic.co.za



Numatic International Schweiz AG.
Sihlbruggstrasse 3A, 6340 Baar. SCHWEIZ
Tel: 0041 (0) 41 76 80 76 - 0 www.numatic.ch

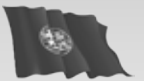

Numatic International ULDA. Rua da Boa Viagem, 177
4470.210 Maia. PORTUGAL
Tel: +351 220 047 700 www.numatic.pt



Numatic International SLU. C/ La Forja, 41, 08840 Viladecans
(Barcelona), Spain
Tel: +34 93 647 22 22 www.numatic.es

Specification subject to change without prior notice
www.numatic.co.uk © Numatic International Limited

244000 06/22 (A16)